

Rotomolded with UV resistant polyethylene
Available in white, yellow, red, green

Spherical buoy hollow

Diameter (mm)	Weight (kg)	Volume (l)	Height (mm)	Height above water (mm)
400	2,5	50	680	380
600	7	130	1000	500
800	12	270	1100	500

Spherical buoy foamed (40kg/m3 polyurethane)

Diameter (mm)	Weight (kg)	Volume (l)	Height (mm)	Height above water (mm)
400	4	50	680	380
600	12	130	1000	500
800	24	270	1100	500

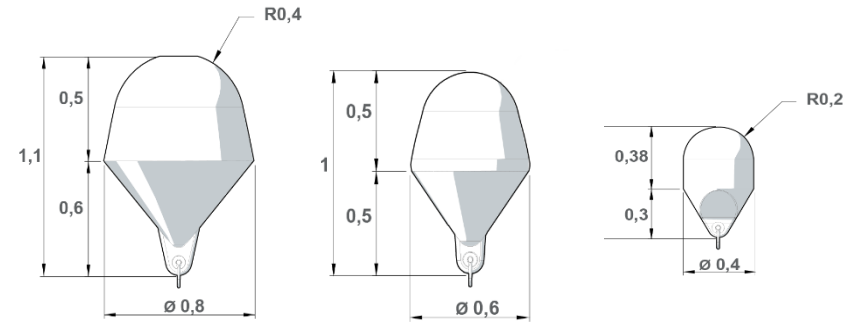

Cylindrical buoy hollow

Diameter (mm)	Weight (kg)	Volume (l)	Height (mm)	Height above water (mm)
400	2,5	30	650	350
600	7	120	1000	500
800	12	260	1300	700

Cylindrical buoy foamed

Diameter (mm)	Weight (kg)	Volume (l)	Height (mm)	Height above water (mm)
400	4	30	650	350
600	10,5	120	1000	500
800	21,5	260	1300	700

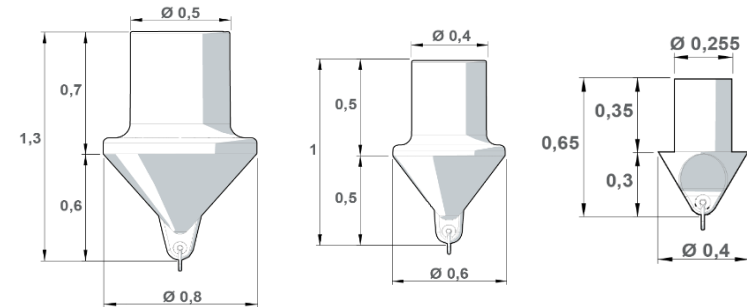

Conic buoy hollow

Diameter (mm)	Weight (kg)	Volume (l)	Height (mm)	Height above water (mm)
400	1,5	30	600	300
600	6	100	1000	500
800	10	210	1200	600

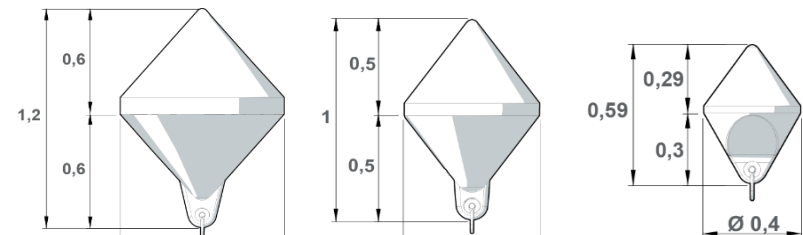

Conic buoy foamed

Diameter (mm)	Weight (kg)	Volume (l)	Height (mm)	Height above water (mm)
400	2,5	30	600	300
600	9,5	100	1000	500
800	19	210	1200	600

Conical truncated buoy hollow

Diameter (mm)	Weight (kg)	Volume (l)	Height (mm)	Height above water (mm)
600	6	100	800	300
800	10	210	1100	500

Conical truncated buoy foamed

Diameter (mm)	Weight (kg)	Volume (l)	Height (mm)	Height above water (mm)
600	9,5	100	800	300
800	19	210	1100	500

Options for Conical truncated buoys

Description
Radar reflector (Aluminium)
St Andrew Cross (Aluminium)
St Andrew Cross (Aluminium) with lantern support

Conical truncated buoys can receive a Carmanah M550 or M650H marine lantern
 2 inserts for dia. 600mm buoy (M550) / 3 inserts for dia. 800mm buoy (M650H or RR+M550 or RR+M650H)

Mooring kit (optional for all buoys) including shackle

ND16mm shackle for dia. 600mm and 800mm

More information on www.fulloceans.com

